

UNLESS OTHERWISE SPECIFIED:
 DIMENSIONS ARE IN MILLIMETERS
 MATERIAL: MILD STEEL
 SURFACE FINISH: CLEAN AND DEBURRED
 TOLERANCES:
 LINEAR: ±1.0mm
 ANGULAR: ±1.0° DEGREES

SCF FABRICATION LTD
 BROMPTON | DULVERTON | SOMERSET
 TA22 9NZ | +44 (0) 1398 371347
 www.scf-fabrication.com

FIRST ANGLE PROJECTION		
DRAWN	BY	DATE
CHECKED	SC	07FEB19
APPROVED	SC	07FEB19

TITLE		
15 95 21 - Site Drawing		
DRAWN BY	REVISION	NOT TO SCALE
damienfieldhouse@gmail.com	1	
© SCF FABRICATION LTD 2019		SHEET 1 OF 4

REVISIONS					
REV.	DESCRIPTION	DRAWN	CHECKED	DATE	APPROVED
1	FIRST ISSUE	DJF	SC	07FEB19	SC

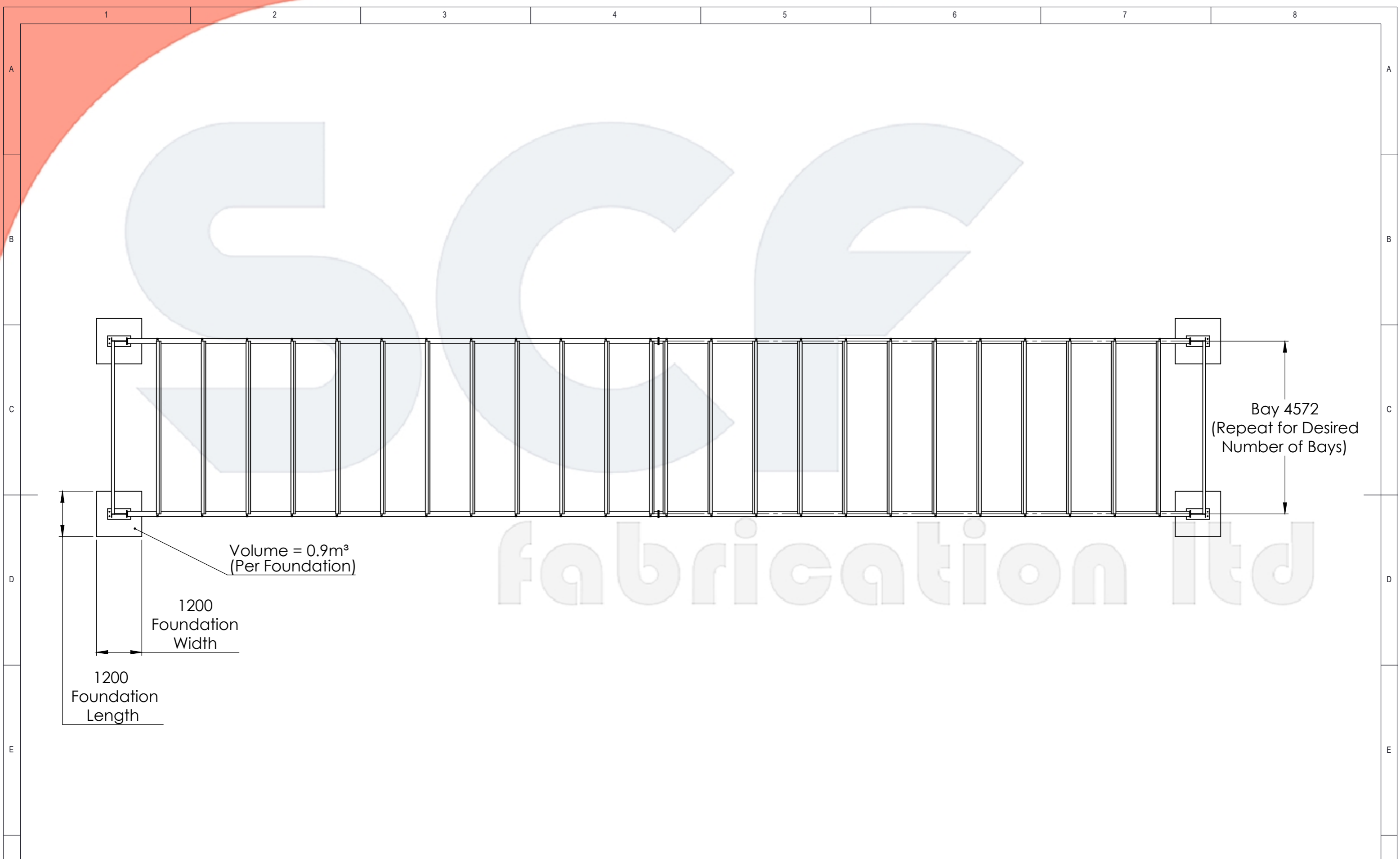

Volume = 0.9m³
(Per Foundation)

1200
Foundation
Width

1200
Foundation
Length

Bay 4572
(Repeat for Desired
Number of Bays)



UNLESS OTHERWISE SPECIFIED:
DIMENSIONS ARE IN MILLIMETERS
MATERIAL: MILD STEEL
SURFACE FINISH: CLEAN AND DEBURRED
TOLERANCES:
LINEAR: ±1.0mm
ANGULAR: ±1.0° DEGREES

SCF FABRICATION LTD
BROMPTON | DULVERTON | SOMERSET
TA22 9NZ | +44 (0) 1398 371347
www.scf-fabrication.com

FIRST ANGLE PROJECTION		
	BY	DATE
DRAWN	DJF	07FEB19
CHECKED	SC	07FEB19
APPROVED	SC	07FEB19

TITLE		
15 95 21 - Site Drawing		
DRAWN BY	REVISION	NOT TO SCALE
damienfieldhouse@gmail.com	1	
© SCF FABRICATION LTD 2019		SHEET 2 OF 4

Base Plate

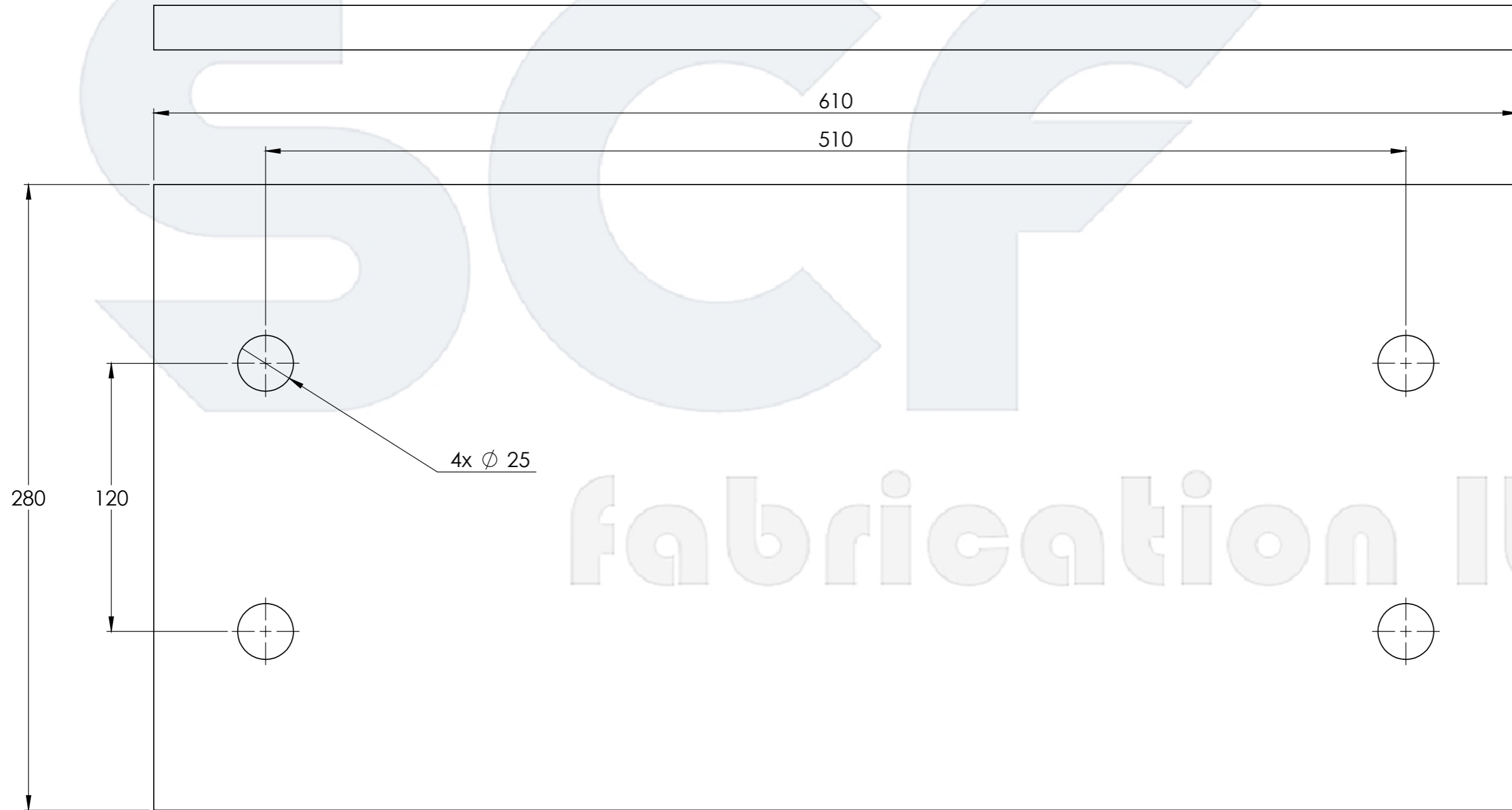

4x Ø 25

280
120

610

510



UNLESS OTHERWISE SPECIFIED:
 DIMENSIONS ARE IN MILLIMETERS
 MATERIAL: MILD STEEL
 SURFACE FINISH: CLEAN AND DEBURRED
 TOLERANCES:
 LINEAR: ±1.0mm
 ANGULAR: ±1.0° DEGREES

SCF FABRICATION LTD
 BROMPTON | DULVERTON | SOMERSET
 TA22 9NZ | +44 (0) 1398 371347
 www.scf-fabrication.com

FIRST ANGLE PROJECTION		
	BY	DATE
DRAWN	DJF	07FEB19
CHECKED	SC	07FEB19
APPROVED	SC	07FEB19

TITLE		
15 95 21 - Site Drawing		
DRAWN BY	REVISION	NOT TO SCALE
damienfieldhouse@gmail.com	1	
© SCF FABRICATION LTD 2019		SHEET 3 OF 4

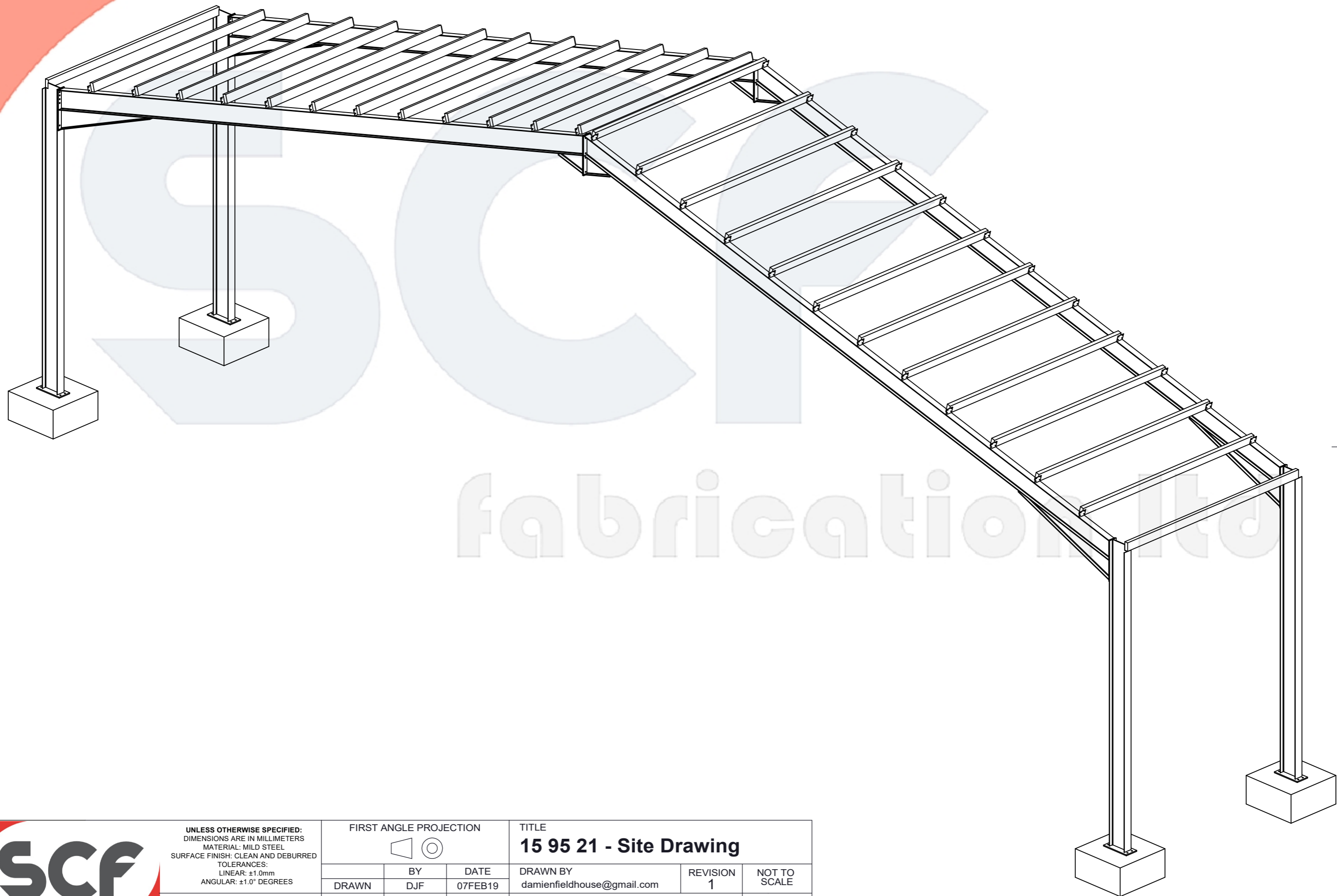

UNLESS OTHERWISE SPECIFIED:
 DIMENSIONS ARE IN MILLIMETERS
 MATERIAL: MILD STEEL
 SURFACE FINISH: CLEAN AND DEBURRED
 TOLERANCES:
 LINEAR: ±1.0mm
 ANGULAR: ±1.0° DEGREES

SCF FABRICATION LTD
 BROMPTON | DULVERTON | SOMERSET
 TA22 9NZ | +44 (0) 1398 371347
 www.scf-fabrication.com

FIRST ANGLE PROJECTION



	BY	DATE
DRAWN	DJF	07FEB19
CHECKED	SC	07FEB19
APPROVED	SC	07FEB19

TITLE

15 95 21 - Site Drawing

DRAWN BY	REVISION	NOT TO SCALE
damienfieldhouse@gmail.com	1	

© SCF FABRICATION LTD 2019

SHEET 4 OF 4